

Gerenciamento de Firewalls em Redes Híbridas

Maurício Fiorenza, **Diego Kreutz**, Rodrigo Mansilha

Redes convencionais

Internet

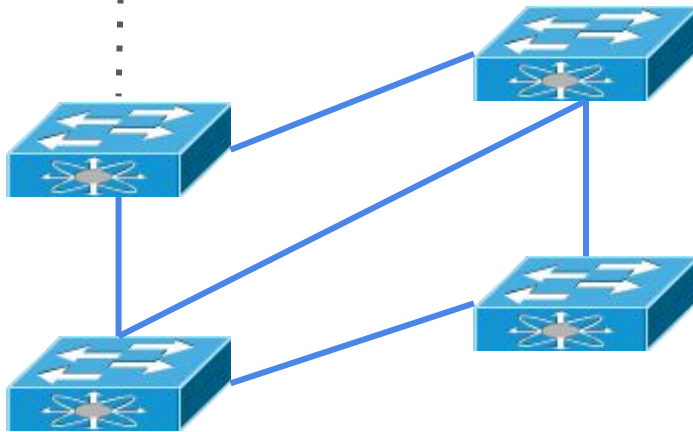

Redes SDN (Software-Defined Networking)

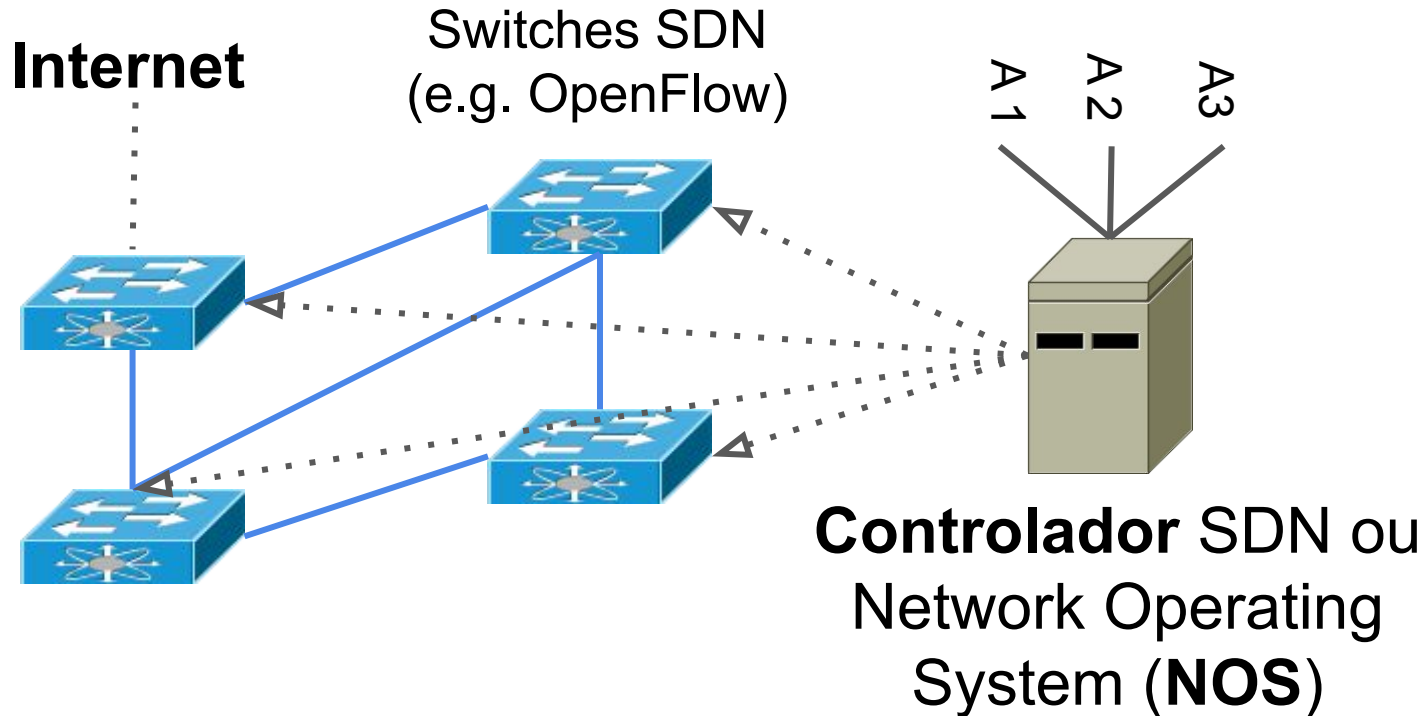

Migração de redes convencionacionais para SDN

Custo CAPEX e OPEX elevado

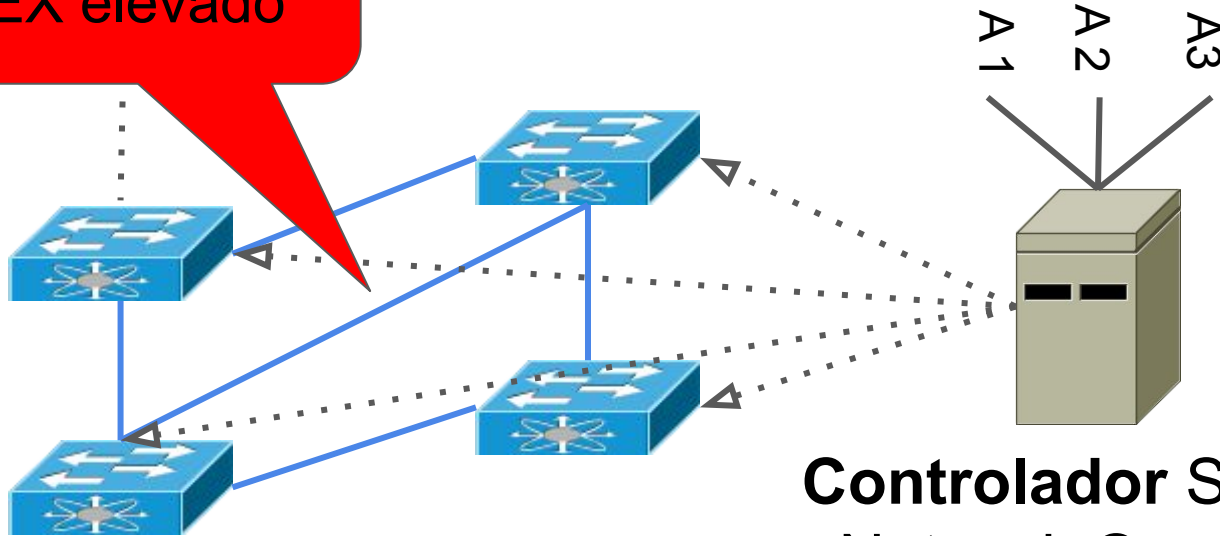

**Controlador SDN ou
Network Operating
System (NOS)**

Rede híbrida: convencional + SDN

Migração progressiva

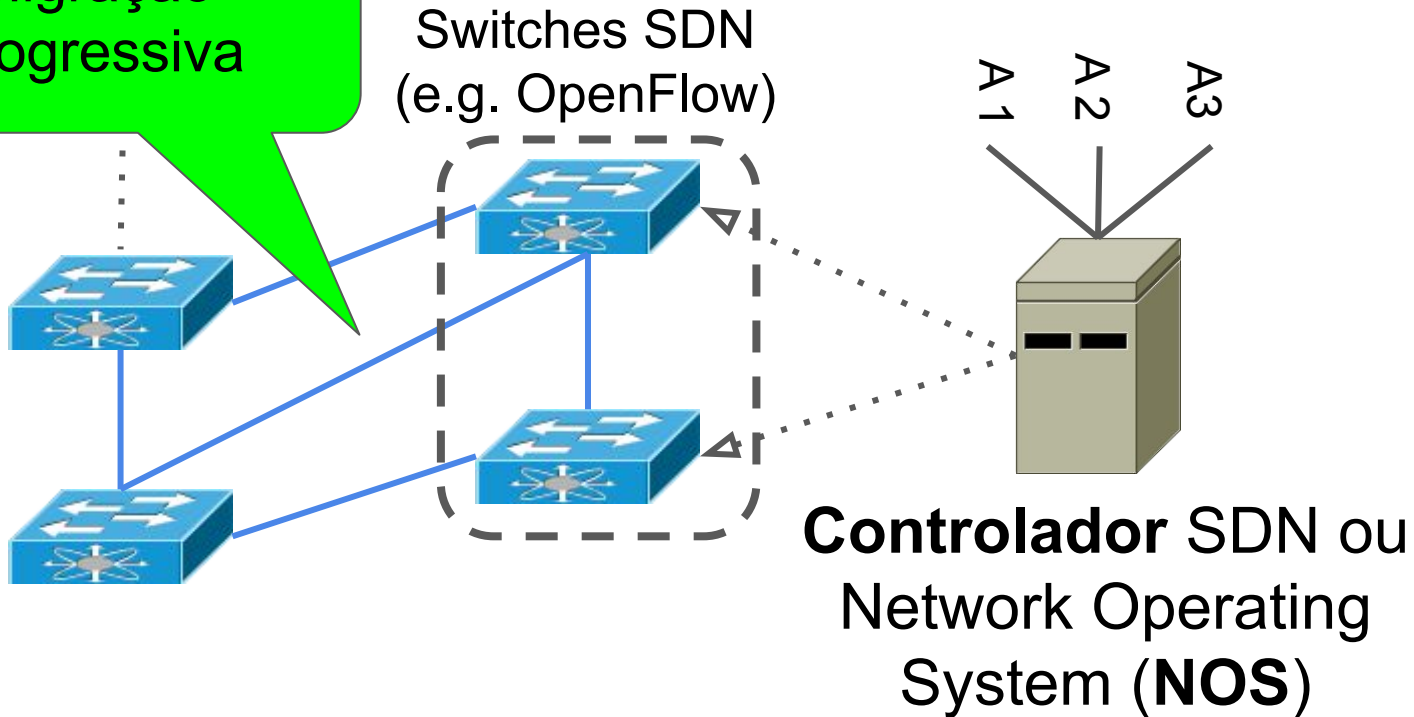

Problema

Proposta

Implementação

Avaliação

Gerenciamento de Firewalls

Firewall Cisco

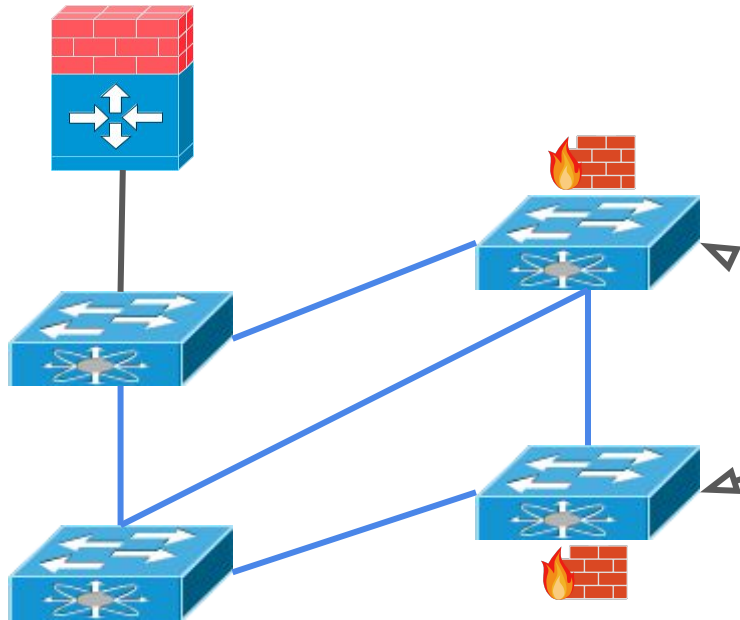

Firewall Openflow

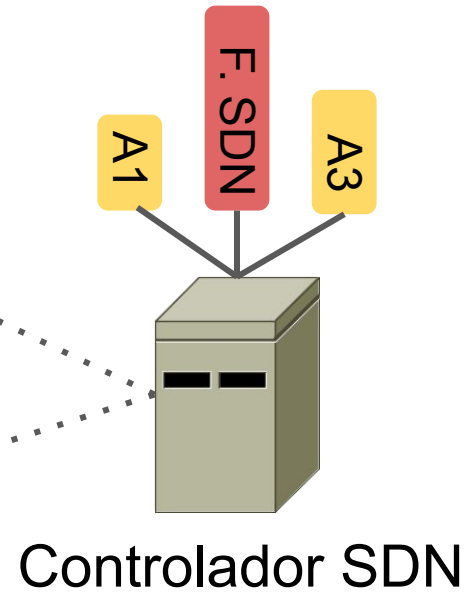

Gerenciamento de Firewalls

- Bloqueio de portas (sintaxe Cisco)

```
!  
configure terminal  
!  
access-list inside_access extended deny tcp any any eq 22  
!
```

- Bloqueio de portas (sintaxe Openflow)

```
!  
ovs-ofctl add-flow br0 tcp,tcp_dst=22,actions=drop  
!
```



Problema

Proposta

Implementação

Avaliação

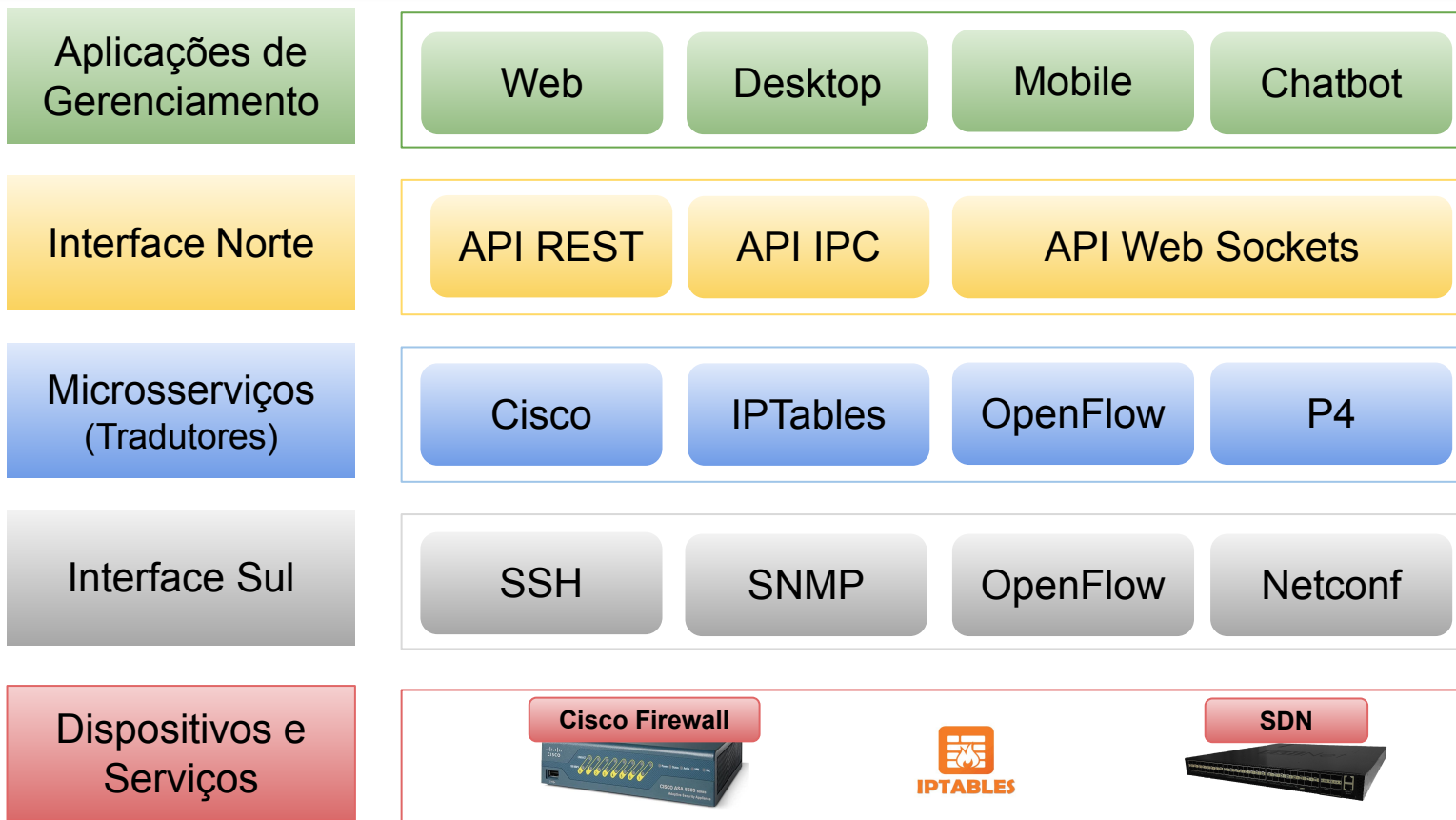
Arquitetura



Arquitetura

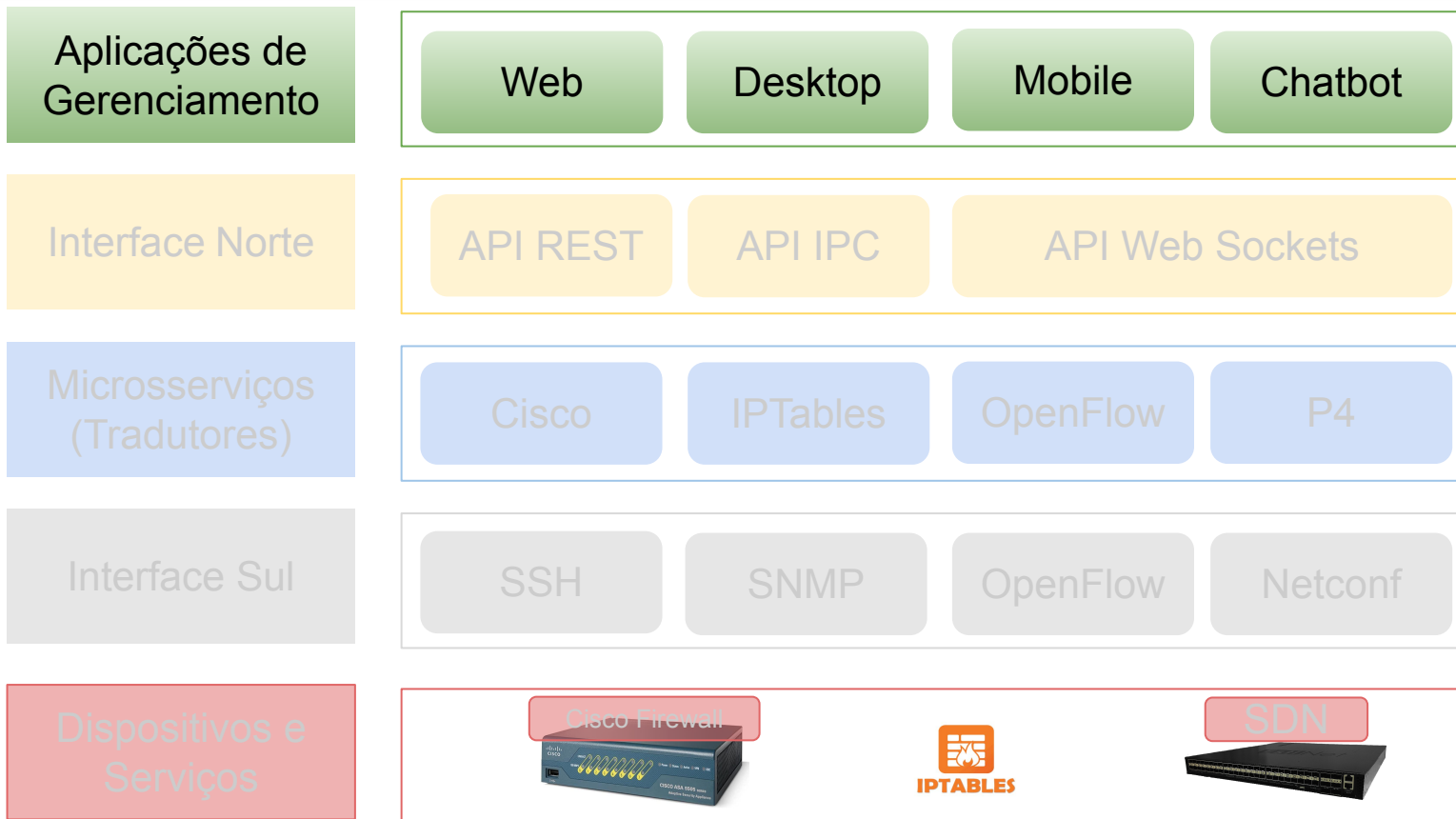

Arquitetura

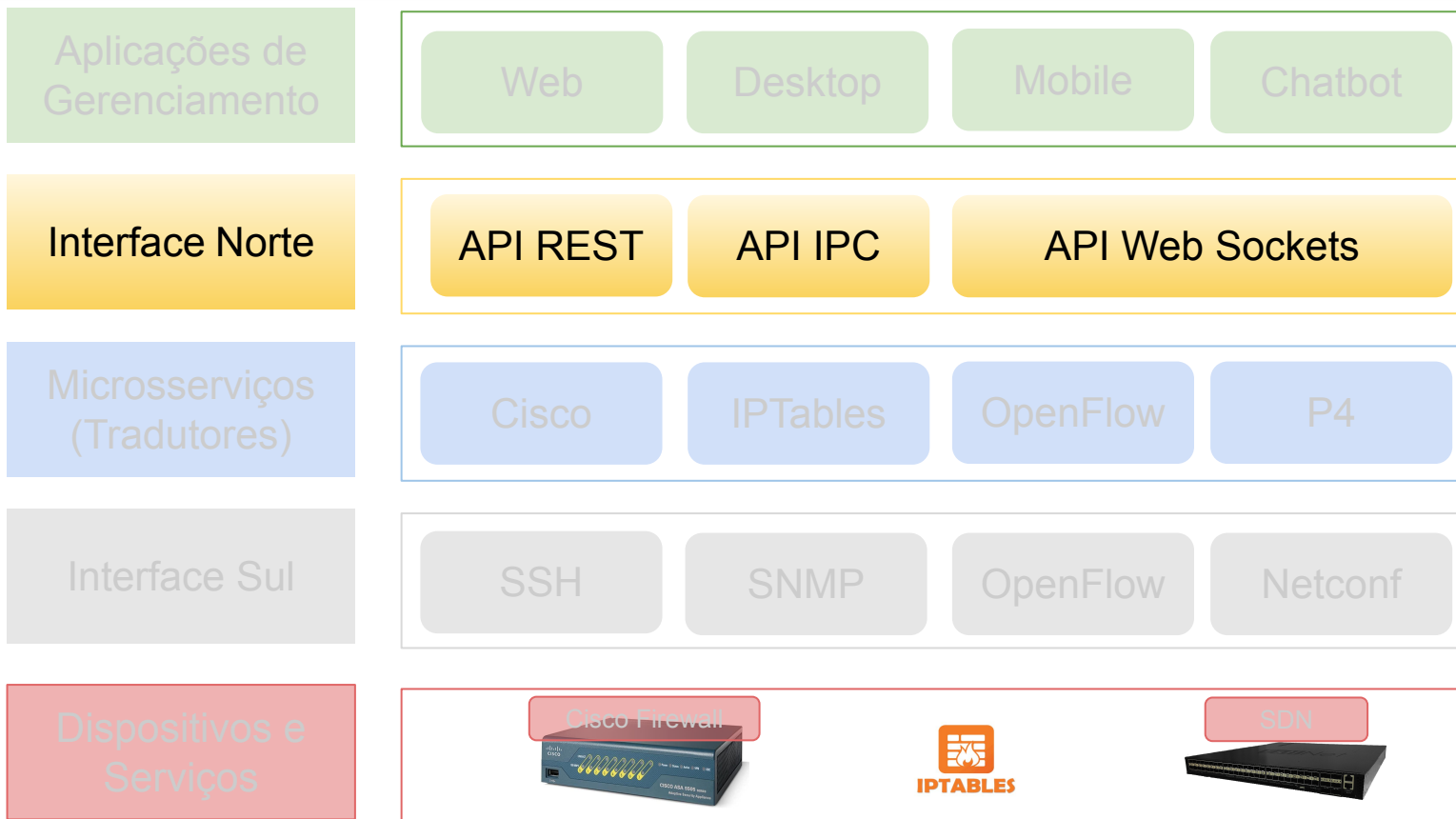

Arquitetura

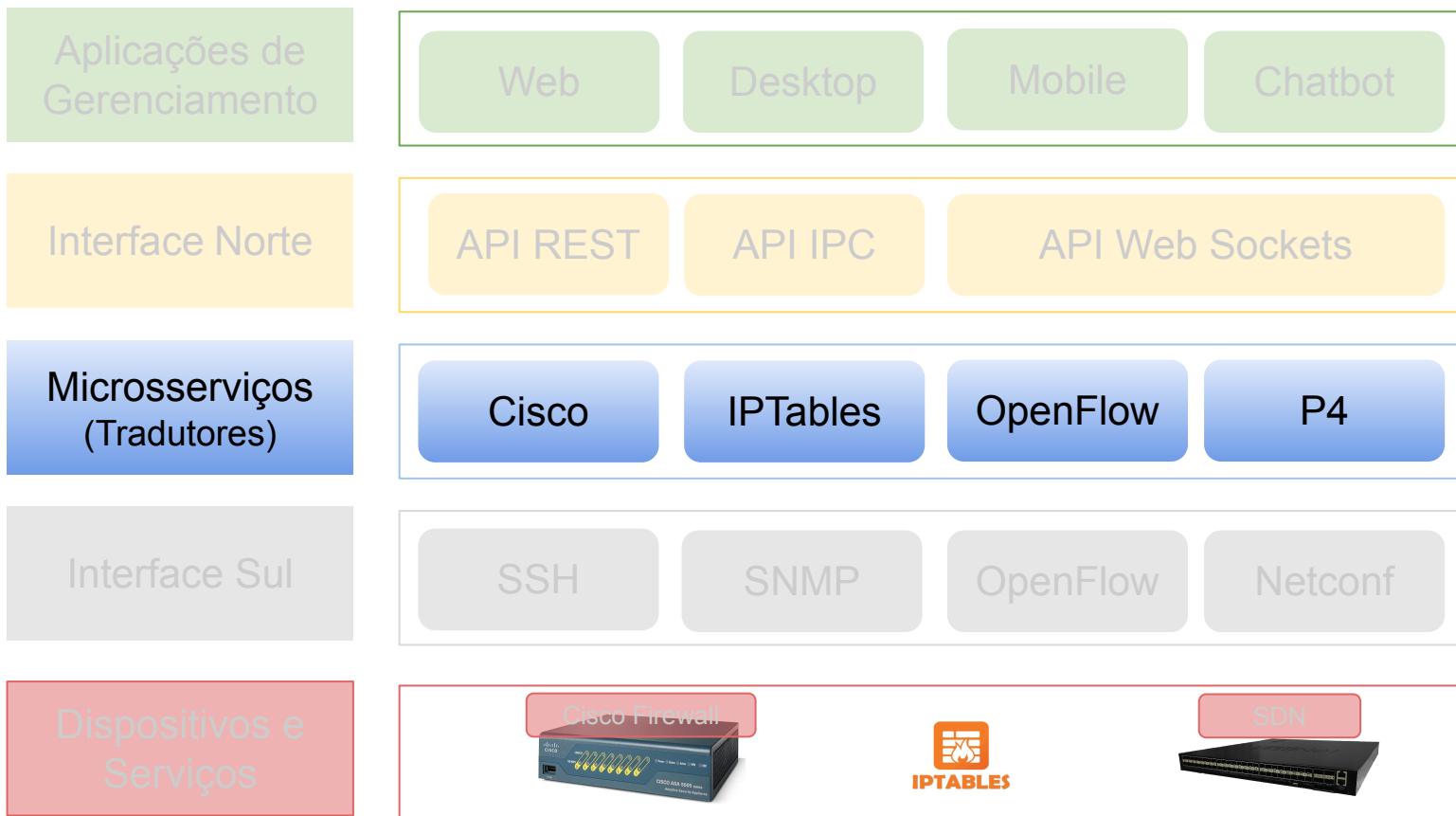

Arquitetura

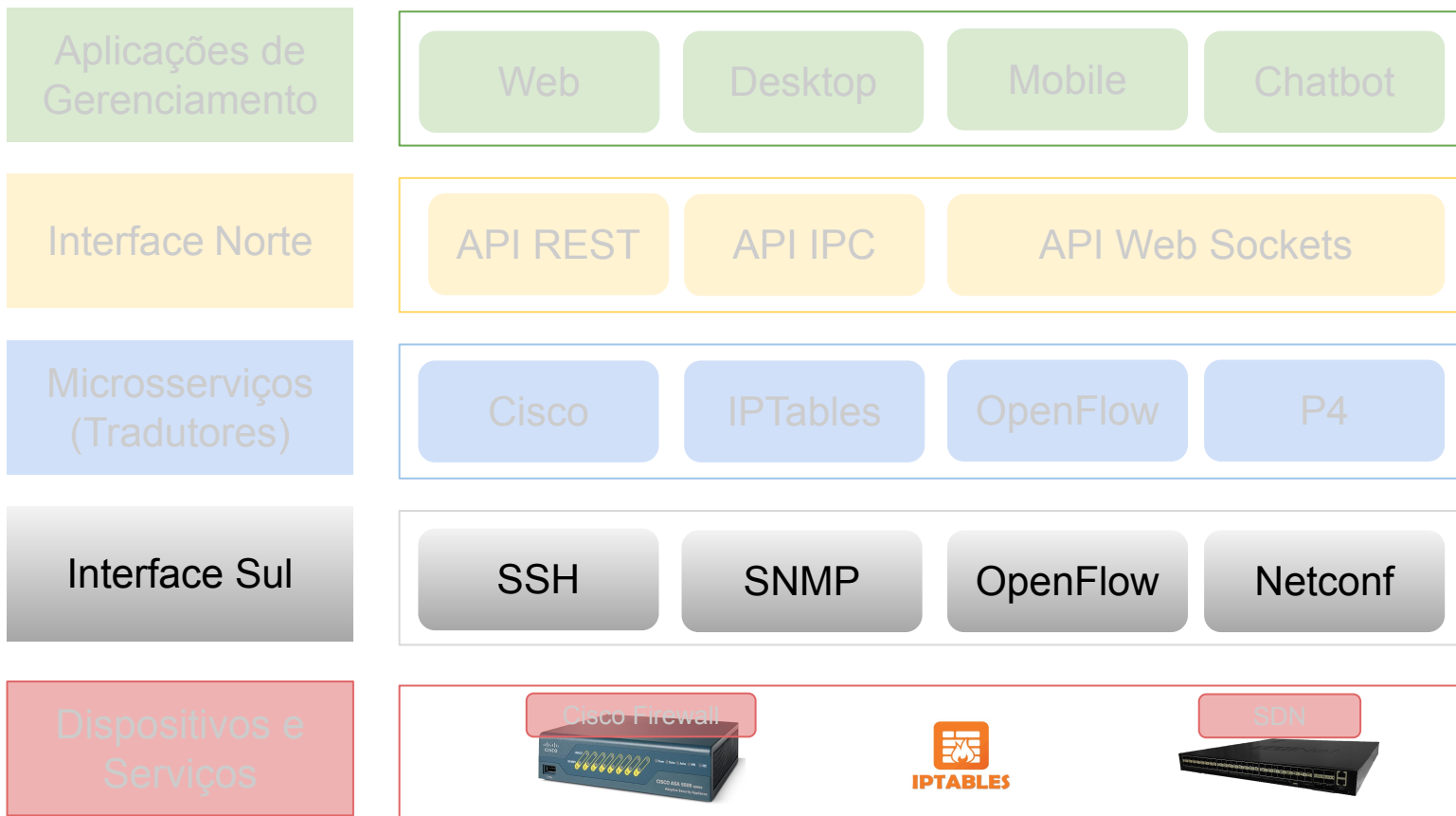

Arquitetura

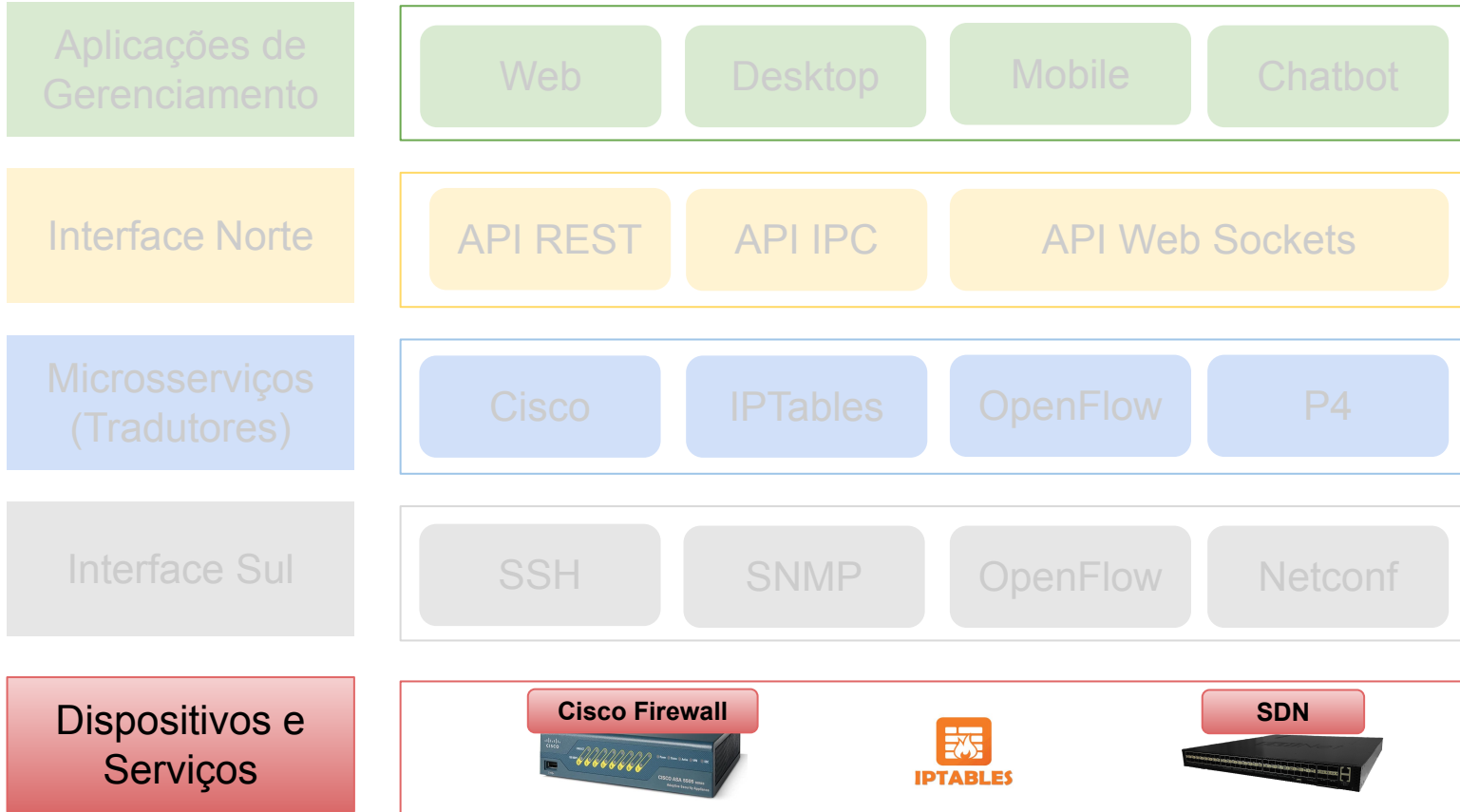

Problema

Proposta

Implementação

Avaliação

Políticas

- ACL
- NAT
- Traffic Shaping

Componentes

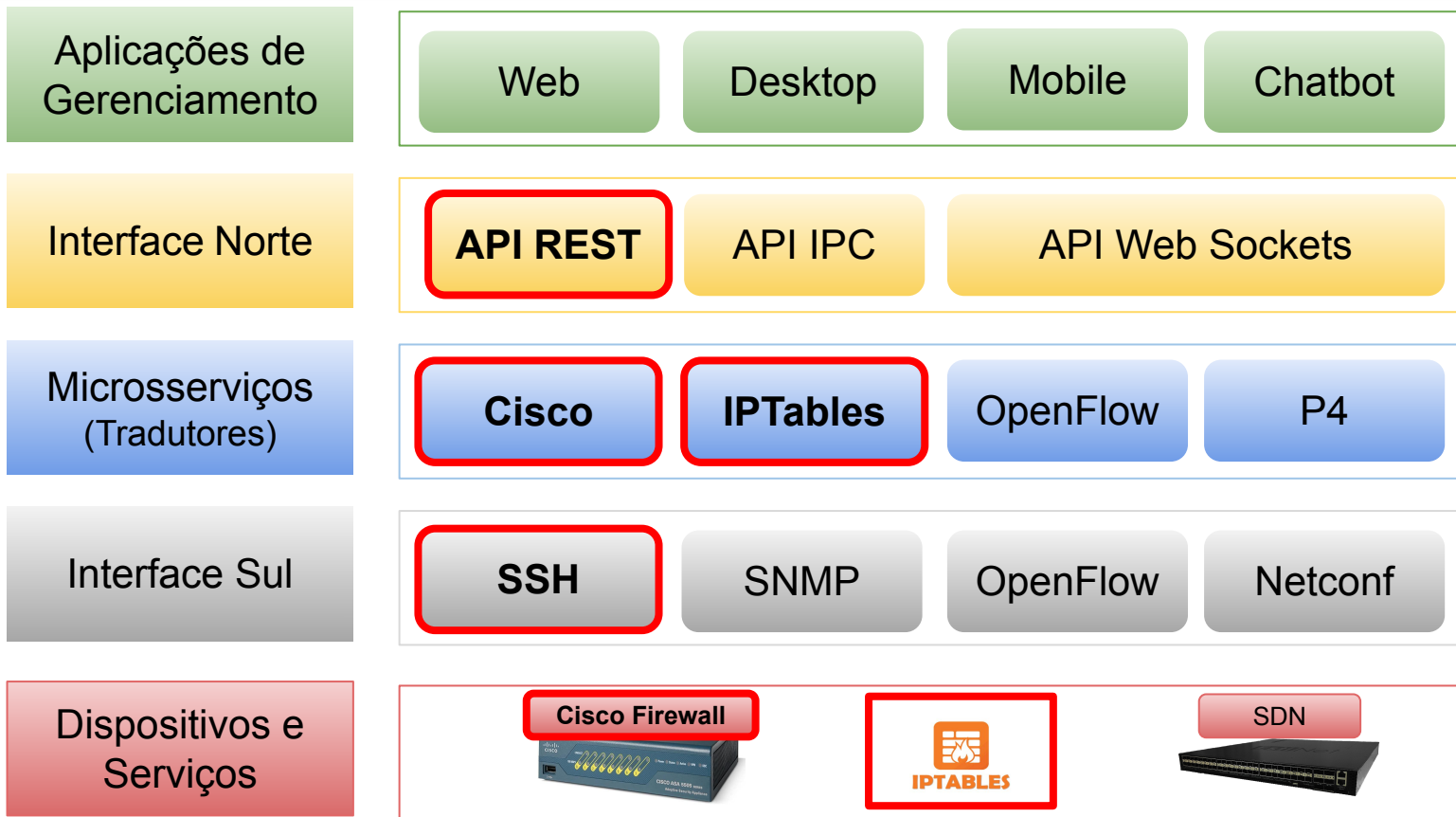

Tecnologias e Protocolos

Aplicações de Gerenciamento

NILE

Interface Norte

Flask

Microserviços (Tradutores)

Jinja2

YAML

Interface Sul

SSH

Dispositivos e Serviços

NILE (linguagem de Intents)

define intent acl:

from range('192.168.1.0/24')

to endpoint('8.8.8.8')

rule allow('https')

apply insert/remove

Problema

Proposta

Implementação

Avaliação

ACL e Traffic Shaping (Ambiente)

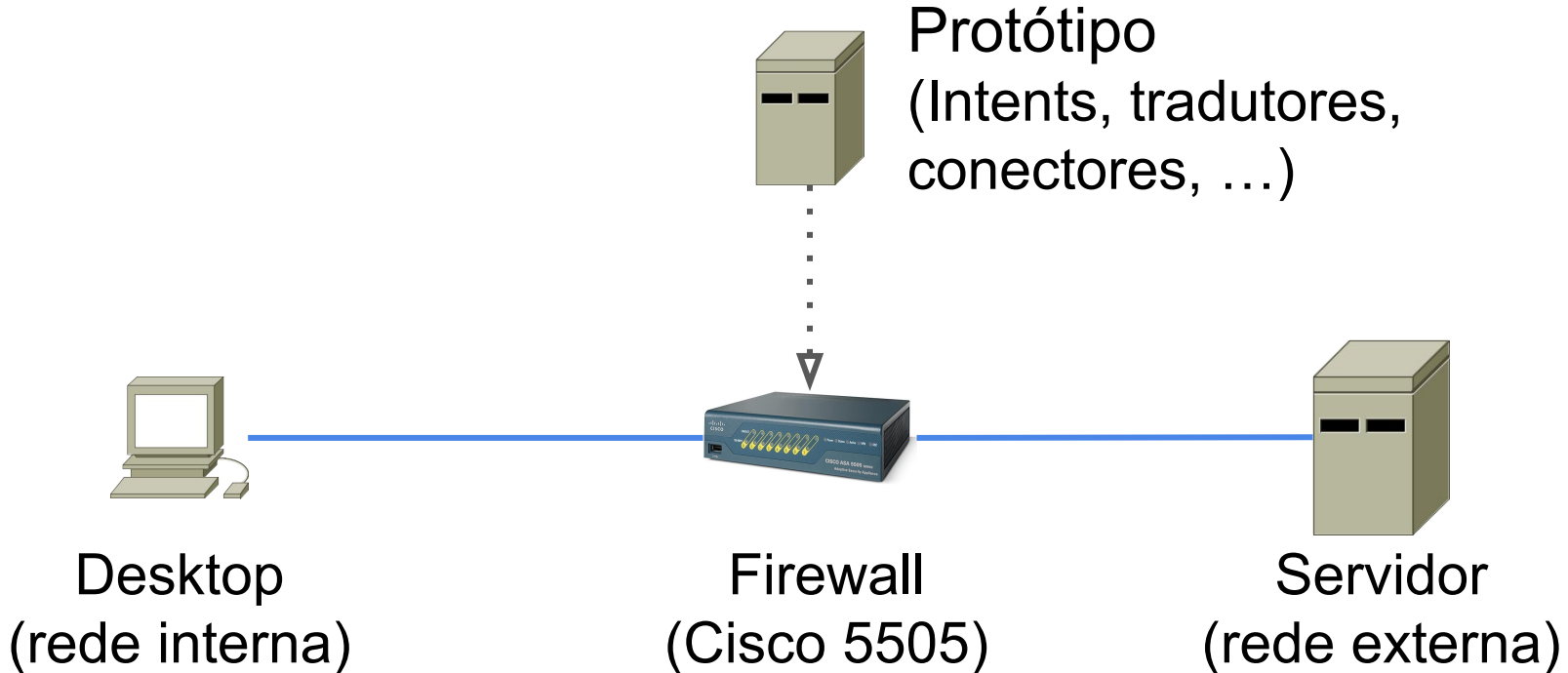

ACL ICMP (Intent)

define intent acl:

from endpoint('192.168.1.2')

to endpoint('200.19.30.2')

rule deny('icmp')

apply insert/remove

ACL ICMP (resultado)

```
usuario@xyz:~$ ping -i4 -0 200.19.30.2
PING 200.19.30.2 (200.19.30.2) 56(84) bytes of data.
64 bytes from 200.19.30.2: icmp_seq=1 ttl=64 time=0.700 ms
64 bytes from 200.19.30.2: icmp_seq=2 ttl=64 time=0.837 ms
64 bytes from 200.19.30.2: icmp_seq=3 ttl=64 time=0.893 ms
no answer yet for icmp_seq=4
no answer yet for icmp_seq=5
64 bytes from 200.19.30.2: icmp_seq=6 ttl=64 time=0.779 ms
64 bytes from 200.19.30.2: icmp_seq=7 ttl=64 time=0.844 ms
64 bytes from 200.19.30.2: icmp_seq=8 ttl=64 time=0.805 ms
```

ACL Traffic Shaping (Intent)

```
define intent traffic_shaping:  
    from      endpoint('192.168.1.2')  
    to        endpoint('200.19.30.2')  
    for       traffic('udp/5555')  
    with      throughput('30Mbps')  
    apply     insert/remove
```

ACL Traffic Shaping (resultado)

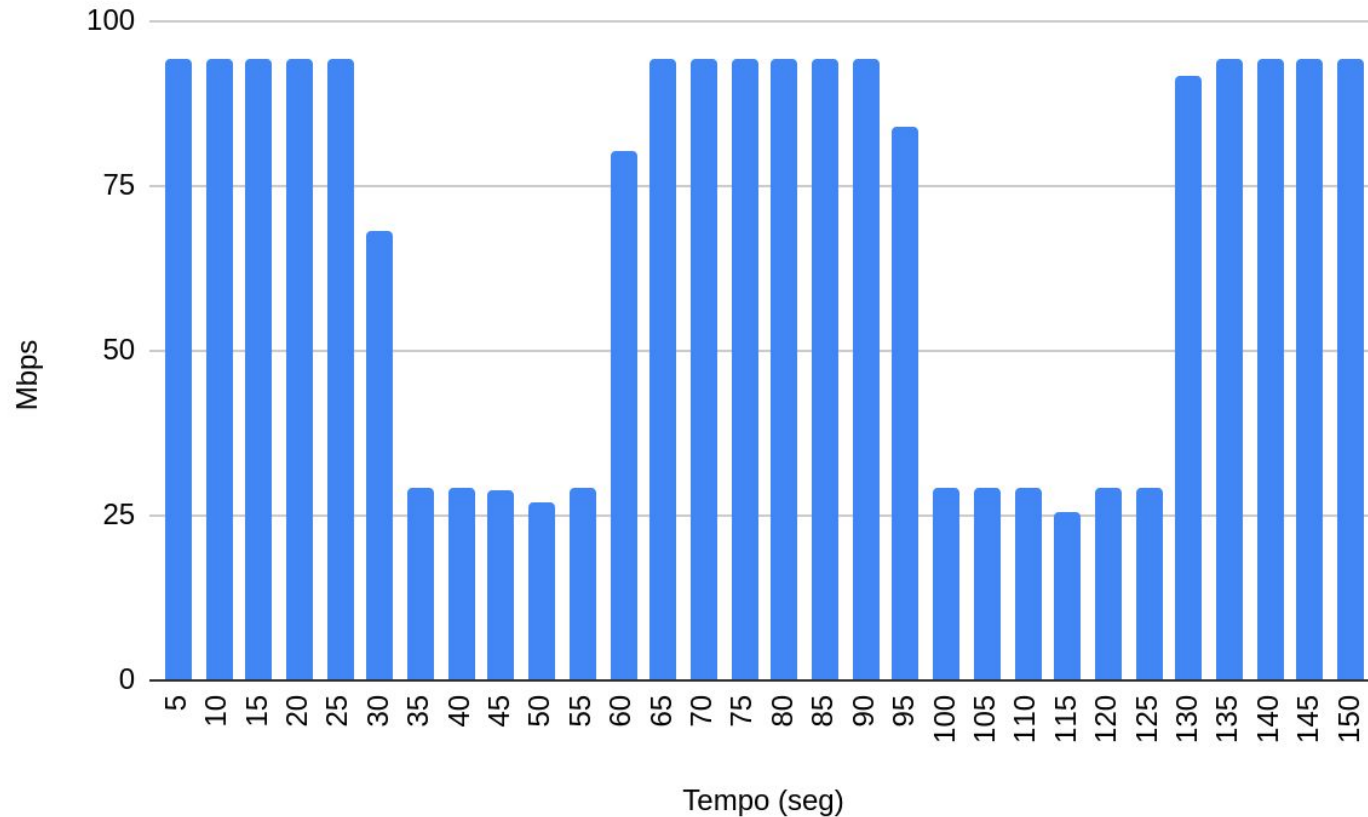

Trabalhos em andamento

